

DUX WATER HEATERS

HOT WATER SOLUTIONS PRODUCT GUIDE



AN ICONIC BRAND

An iconic Australian brand since 1915, Dux is committed to producing high quality water heaters and to the on-going development of new products for the Australian market.

Dux water heaters are manufactured in a state-of-the-art facility in regional NSW, using a Quality Endorsed Company production system. This ensures that customers have purchased the highest quality water heater available.

Dux is proudly owned by Noritz, an international hot water powerhouse and a leading Japanese manufacturer of residential and commercial water heaters.



Moss Vale, NSW

MARATHON WARRANTY

All Dux water heaters are backed by our Marathon® Warranty. It's designed to provide peace of mind over the warranted term of the water heater.

DESIGNED TO GO THE DISTANCE

We prioritise quality into the design and manufacture of our hot water systems to make one of the best water heaters possible. The process begins with robust designs from our local research and development team. We specify superior 'Plus plus' cylinder designs in the majority of our storage products, combined with high strength steel and commercial grade enamel for longer product life. We leak test tanks from each days production for even greater quality assurance.

It's why we say our products are **Built stronger to last longer™**.

Akashi, Japan



proflo[®] for homes of all sizes

RELIABLE HOT WATER SYSTEMS THAT WILL GO THE DISTANCE

If you're looking to replace an existing electric storage water heater, Proflo is an ideal solution - available in a variety of tank sizes for homes of all sizes and delivering full mains pressure.

PROFLO 25L & 50L

- Proflo 50L boasts a compact 670mm height, making it an easier fit into tight cupboards
- V-Fit plumbing connections provide better access for easier installation
- Available as hardwired or plug-in models
- Made in a Noritz manufacturing facility
- 7 year tank warranty, 1 year parts and labour*

PROFLO 80L - 400L

- 80L - 400L Proflo water heaters boast a larger anode to increase tank life
- Feature durable Y class commercial grade enamel
- Hard-wearing, tough polymer base resists damage and is rust-proof
- Feature 50mm thick, dense foam insulation for less heat loss and lower running costs
- Twin element models available
- Made in Australia
- 10 year tank warranty, 1 year parts and labour*

RANGE FEATURES

- Water connections on both sides of the tank
- Screwless tank lids offer a cleaner appearance and are safer to handle
- Low maintenance and long service life
- Full flow pressure to all outlets
- Can be installed indoors or out#

CAPACITY	NO. OF PEOPLE PER HOME	
	Continuous Tariff	Off Peak
25L	-	-
50L	1	-
80L	1 - 2	-
125L	2 - 3	-
160L	2 - 4	-
250L	3 - 5	1 - 3
315L	4 - 6	2 - 4
400L	5 - 9	4 - 6

In relation to usage a person can represent a dishwasher or washing machine.
 Continuous Tariff; Provides power so that your water can be heated at any time of the day or night.
 Off Peak; Generally only provides power to your water heater for between 6-12 hours a night - check with your local electricity retailer for details of off-peak hours.
 #Plug in models can only be installed indoors.



SO MANY SIZES FOR HOT WATER YOU CAN'T GO WRONG.

prodigy[®] 4 & 5 star gas storage

NO EXTRA SPACE NEEDED TO INSTALL AN EFFICIENT PRODUCT

Gas storage hot water systems give you full mains pressure with a constant, strong stream of hot water.

If you're looking to replace an existing gas storage water heater, Dux Prodigy is an ideal solution. The range consists of both 4 and 5 star models that feature similar dimensions to older square gas units, allowing easy replacement with higher efficiency models.

PRODIGY 4 STAR

- Market leading in hot water recovery and first hour capacity†
- 7 year tank warranty, 1 year parts and labour*

PRODIGY 5 STAR

- The Prodigy 5 135L is the most efficient gas storage water heater in the Australian market‡
- Up to 5.4 star energy efficiency#
- Improved patented flue damper design reduces heat loss
- 10 year tank warranty, 5 year parts and labour on flue damper, 1 year other parts and labour*

RANGE FEATURES

- Powerful burner technology means faster recovery rates and more hot water when you need it
- Dual anodes to further increase tank life
- Features durable Y class commercial grade enamel
- Similar footprint with older square gas storage water heaters
- Mains pressure hot water
- Inline foam filling process provides superior insulation and a more robust design
- No power point required so hot water continues, even during power interruptions
- Operates on a standard size ½" gas line
- Available in both natural gas and propane models
- Made in Australia

FIRST HOUR CAPACITY	STORAGE CAPACITY	RECOVERY RATE (L/hr) ^o	FIRST HOUR CAPACITY
Prodigy 4	135L	126L	261L
Prodigy 4	170L	146L	316L
Prodigy 5	135L	126L	261L
Prodigy 5	170L	141L	311L

	CAPACITY (L)	NO. OF PEOPLE PER HOME
prodigy	135	2 – 4
prodigy	170	3 – 5

In relation to usage a person can represent a dishwasher or washing machine.

NEW AND IMPROVED TECHNOLOGY MAKES THE DIFFERENCE

† In the 4 star gas storage class. ^oRecovery rate for Prodigy natural gas models only.
 #Prodigy 5 135L is rated at 5.4 stars energy efficiency, Prodigy 5 170L is rated at 5.2 stars energy efficiency.
 ^Prodigy 5 135L model has the lowest annual energy consumption of 19,953 MJ/year of any gas storage water heater registered with GEMS.



PRODIGY 4 STAR



135L

170L

PRODIGY 5 STAR



135L

170L

Both Prodigy 4 and 5 star gas storage models feature a similar footprint as older square gas storage water heaters, allowing easy replacement of older systems.



gas continuous flow

HOT WATER THAT NEVER RUNS OUT

Never run out of hot water again with a Dux Always Hot continuous flow. They are compact in size, highly energy efficient and are backed by a 12 year heat exchanger warranty.

Available in four different capacities and even the option of dual heat exchanger models^Δ for greater running cost savings. There's a model to suit every family.

NON-CONDENSING MODELS

- Available in 17L, 21L, 26L and 32L/min models
- Up to 6.4 star equivalent energy efficiency[†]
- Single copper heat exchanger for efficient heating

CONDENSING MODELS

- Available in 21L and 26L/min models
- Up to 6.7 star equivalent energy efficiency[†]
- Dual heat exchanger design boasts over 90% thermal efficiency by capturing additional heat

RANGE FEATURES

- Never runs out of hot water
- Superior technology straight from Noritz, a leading manufacturer of continuous flow water heaters
- Electronic ignition means no standby pilot light
- Natural gas and LPG models
- 12 year warranty on heat exchanger, including 3 year parts and labour*



Dux Always Hot provides the choice between high performance (non-condensing) and ultra-high performance (condensing) continuous flow models.

SIZING	MODELS			
	17L	21L	26L	32L
No. of Outlets	2	2-3	3	4

ACCESSORIES



Accessories include separate controllers that allow you to select the hot water temperature you prefer – a welcome safety and convenience feature for families.

Optional accessories include:

- Pipe covers
- Recess boxes
- Anti-theft kit
- Flue diverters

See Accessories Specification brochures on www.dux.com.au for part numbers.

HOT WATER ON DEMAND WHEN YOU NEED IT

NON-CONDENSING

Water passes through a single copper heat exchanger and the energy from the exhaust gas vents to the atmosphere.

EXHAUST TEMPERATURE IS APPROX 200°C

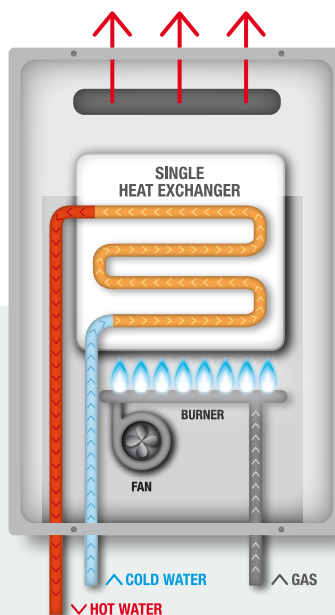

(Conventional technology)
Thermal efficiency = 80-84%

CONDENSING

Water is heated in the primary heat exchanger, and again in a secondary heat exchanger using waste heat from the exhaust gas. This reduces energy use and lowers the exhaust gas temperature.

EXHAUST TEMPERATURE IS ONLY 50°C

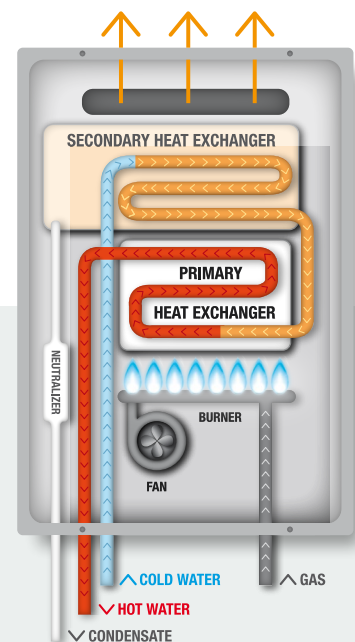

(Condensing technology)
Thermal efficiency = 90-96%

[†]21ECB & 26ECB models are rated 6.7 stars. 17ENB models are rated 6.0 stars. 21ENB models are rated 6.1 stars. 26ENG models are rated 6.4 stars. 32END models are rated 5.8 stars. Relates to the equivalent star rating for the water heater. ^Δ21ECB & 26ECB are condensing models featuring dual heat exchangers.

airoheat® *air-sourced heat pump*

POWERFUL, EFFICIENT AND KINDER TO THE ENVIRONMENT

If your home doesn't offer suitable roof space and orientation for installing solar collectors, Airoheat is the next best choice in environmentally friendly water heaters, without the need for solar panels.

Working like a refrigerator but in reverse, it takes air in from outside the tank and uses it to heat water. Its patented in-tank heating coil is fully immersed in water, ensuring direct heat transfer. This eliminates exposure to heat loss issues often associated with other styles of heat pumps.

- High efficiency design for lower running costs
- Single piece, integrated design allows for faster installation
- Dual anodes provide greater protection against tank corrosion
- Powerful compressor for greater heating capacity
- Patented in-tank, dual wall heating coil to improve heat transfer
- Improved thermal efficiency minimises heat loss due to a fully insulated storage tank
- Water connections on both sides of tank provide easy installation
- Composite condensation tray is designed for rapid drainage in high rainfall areas
- Eligible for Small-scale technology certificates
- 5 year tank warranty, 2 year refrigerant components, 1 year parts and labour*



airoheat® heat pump	
CAPACITY (L)	NO. OF PEOPLE PER HOME
250	3 – 5

In relation to usage a person can represent a dishwasher or washing machine. Based on connection to continuous tariff. Size figures are based on environmental averages which can effect the performance of solar and heat pump heaters.

PRODUCT CODE: D2FHG4HW0C	STC ZONE ^o				
	1	2	3	4	5 [†]
<small>Includes a 10% reduction in the number of STCs</small>					
250L HEAT PUMP	17	16	20	21	21 [†]



[†]Refer to www.dux.com.au/zones for postcodes in Zone 5.

^oSystems eligibility for STCs and STC values are subject to change without notice and are correct at time of printing. STCs calculations are based on continuous tariff. STC values attributable to solar and heat pump water heaters are being reduced by 10% per year as of 2023. The values stated in the tables above match the values published in the register of solar water heaters. These include a reduction in STCs (checked June 2022). Use the STC calculator link www.rec-registry.gov.au/rec-registry/app/calculators/sw-h-stc-calculator to calculate the number of STC your installation is eligible for. The systems eligibility for STC's will be based on the year in which the system was installed.

AUSTRALIA'S MOST HIGHLY AWARDED ENVIRONMENTAL WATER HEATER

ecosmart[®] powered by the Australian sun[®]

OUTSTANDING EFFICIENCY TO HELP REDUCE ENERGY BILLS

If you're aiming to reduce your carbon footprint, choose an Ecosmart solar water heater. Ecosmart solar uses the sun's energy to heat water via roof mounted solar collectors. Available in a choice of electric or gas boosted models, ensuring hot water on cloudy days or in times of high demand.

Ecosmart solar will save you money on energy bills, providing an economical, sustainable hot water solution for years to come.

- Split system design provides flexible installation locations without the need for expensive roof reinforcement
- Available in electric or gas boosted models
- Multi-temperature sensors on a vitreous enamel tank configuration enable optimum solar gain while reducing the risk of overheating
- High performance solar collectors ensure efficient transfer of heat to water
- European manufactured circulating pump and smart system controller
- Efficient, polyurethane insulated storage tank
- Features durable Y class commercial grade enamel and a larger anode to increase tank life
- Supplies mains pressure hot water
- Eligible for Small-scale technology certificates (STCs)
- 7 year tank warranty, 5 year collector warranty, 1 year parts and labour*

Available in NSW, South East QLD and WA.

MAKES SENSE... SAVES \$\$\$\$

You can trade your STCs to earn a discount of up to approx \$1,400* off the cost of your new solar water heater.

Dux Ecosmart solar water heaters boast one of the highest number of STCs, meaning you'll save more with Dux.

STC ZONES



electric boosted solar			STC ZONE [ⓐ]				
Includes a 10% reduction in the number of STCs			COLLECTORS	1	2	3	4
250L	D2M36F202	2	31	34	30	27	
315L	D3M36F202	2	32	34	31	27	
315L	D3M36F203	3	35	36	36	32	
400L	D4M36F202	2	31	34	30	27	
400L	D4M36F203	3	35	36	36	35	

CAPACITY	ELECTRIC BOOSTED	GAS BOOSTED
250L	2 – 4	2 – 5
315L	3 – 5	3 – 6
400L	4 – 7	4 – 9

In relation to usage a person can represent a dishwasher or washing machine. Size figures are based on environmental averages which can effect the performance of solar and heat pump heaters. Based on connection to continuous tariff.

gas boosted solar			STC ZONE [ⓐ]				
Includes a 10% reduction in the number of STCs			COLLECTORS	1	2	3	4
250L	D2F20226N	2	30	33	30	26	
315L	D3F20226N	2	30	33	30	26	
315L	D3F20326N	3	35	36	36	32	
400L	D4F20226N	2	30	33	30	26	
400L	D4F20326N	3	35	36	36	32	

[ⓐ]Systems eligibility for STCs and STC values are subject to change without notice and are correct at time of printing. STCs calculations are based on continuous tariff. STC values attributable to solar and heat pump water heaters are being reduced by 10% per year as of 2023. The values stated in the tables above match the values published in the register of solar water heaters. These include a reduction in STCs (checked June 2022). Use the STC calculator link www.rec-registry.gov.au/rec-registry/app/calculators/swh-stc-calculator to calculate the number of STC your installation is eligible for. The systems eligibility for STCs will be based on the year in which the system was installed. ^Calculation references STC eligibility of D3M36F203 in zone 3 (41) and STC valuation of \$35 per STC.



ELECTRIC BOOSTED



GAS BOOSTED

INVIGORATING HOT WATER IN ANY KIND OF WEATHER

PROFLO[®] ELECTRIC STORAGE

proflo small electric

SPECIFICATIONS	25S124P [^]	25S136	50S124P [^]	50S136
Storage Capacity (L)	31	31	50	50
Hot Water Delivery (L)	25	25	50	50
Net Weight Empty (kg)	17	17	23	23
Element Size (kW)	2.4	3.6	2.4	3.6
Relief Valve Pressure (kPa)	1000	1000	1000	1000
Max Inlet Pressure (kPa)	800	800	800	800

[^] Proflo Plug-in model (plugs into standard power point)

TANK DIMENSIONS (MM)	25L	50L
A Overall Height	455	670
B Overall Diameter	405	405
C Hot Water Outlet	275	490
D Cold Water Inlet	145	145
E Electrical Entry	70	70

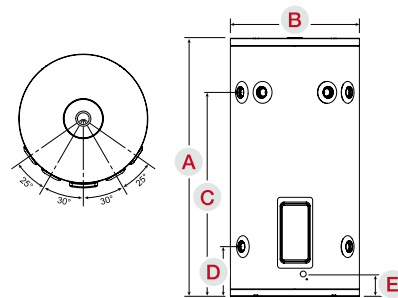

proflo large electric

SPECIFICATIONS	80T1	125X1 NARROW DIAMETER	125T1	160T1	250T1	315T1	315T2 TWIN ELEMENT	400T1	400T2 TWIN ELEMENT
Storage Capacity (L)	88	132	130	161	259	321	321	415	415
Hot Water Delivery Rating (L)	80	125	125	160	250	315	315	400	400
Twin Element Boost Capacity (L)	-	-	-	-	-	-	50	-	80
Element Sizes (kW)	1.8, 2.4, 3.6	1.8, 3.6	1.8, 3.6	2.4, 3.6	3.6	3.6	2 x 3.6 or 2 x 4.8	3.6	2 x 3.6
Net Weight Empty (kg)	41	54	51	59	72	93	93	115	115
Relief Valve Pressure (kPa)	1400	1400	1400	1400	1000	1000	1000	1000	1000
Max Inlet Pressure (kPa)	1120	1120	1120	1120	800	800	800	800	800

All Dux Proflo water heaters are dual-handed for ease of installation and operate at 240V AC single phase electricity supply.

TANK DIMENSIONS (MM)	80L	125L NARROW DIAMETER	125L	160L	250L	315L	400L
A Overall Height	925	1300	1090	1315	1445	1765	1705
B Overall Diameter	490	490	530	530	620	620	705
C Cold Water Inlet	160	160	190	190	195	195	220
D Hot Water Outlet	735	1115	865	1095	1210	1530	1445

125L NARROW DIAMETER SPECIFICATIONS

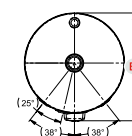

80L - 400L STANDARD MODELS

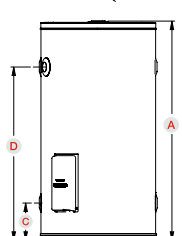
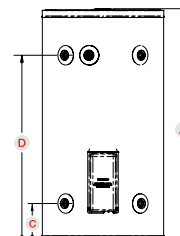
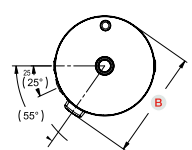

PRODIGY® GAS STORAGE

SPECIFICATIONS	prodigy ⁴		prodigy ⁵	
	135ZB4N/135ZB4P	170ZB4N/170ZB4P	135DC5N/135DC5P	170DC5N/170DC5P
Nominal Capacity (L)	135	170	135	170
Net Weight Empty (kg)	72	86	73	87
Relief Valve Pressure (kPa)	1400	1400	1400	1400
Gas Consumption (Propane) (MJ/h)	25.5	32	25.5	32
Gas Consumption (NG) (MJ/h)	28.5	33	28.5	32
Energy Star Rating	4.5	4.3	5.4	5.2

TANK DIMENSIONS (MM)	135L	170L
A Overall Height Outdoor	1600	1900
B Hot Water Outlet	1325	1620
C Cold Water Inlet	220	220
D Gas Inlet	300	300

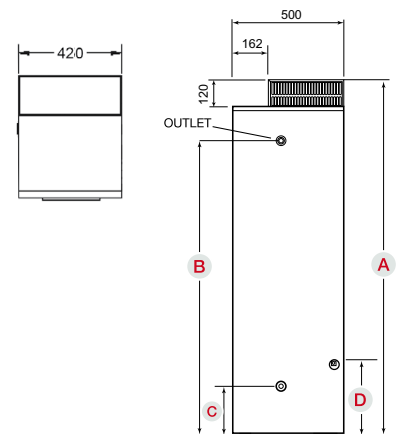

AIROHEAT® HEAT PUMP SYSTEM

SPECIFICATIONS	airoheat
	D2FHG4HW0C
Storage Capacity (L)	250
Net Weight Empty (kg)	107
Power Consumption (General Tariff - kW)	1.2
Max Water Supply Pressure (kPa)	800
Relief Valve Pressure (kPa)	1000
Rated Voltage	240V ac

Not suitable for installation in alpine areas or areas above 1000m.

TANK DIMENSIONS (MM)	
A System Height	1710
B System Width	660
C Inlet	195
D Outlet	1210

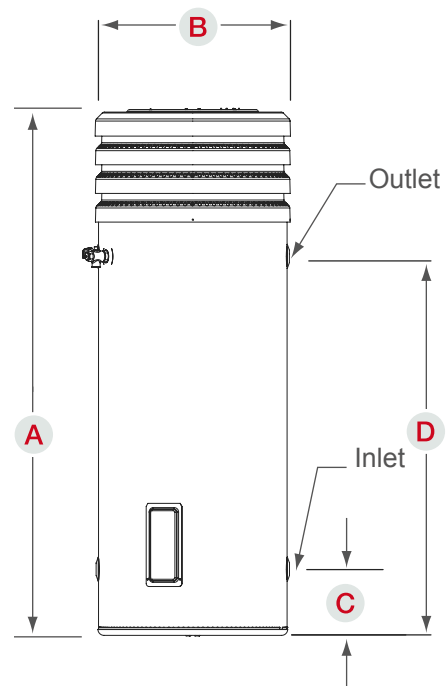

ALWAYS HOT GAS CONTINUOUS FLOW

SPECIFICATIONS	CONDENSING MODELS			NON-CONDENSING MODELS		
Model Number (pre-set 50°C)	21ECB5N / 21ECB5L	26ECB5N / 26ECB5L	17ENB5N / 17ENB5L	21ENB5N / 21ENB5L	26ENG5N / 26ENG5L	32END5N / 32END5L
Model Number (temp. unlocked)	21ECB6N / 21ECB6L	26ECB6N / 26ECB6L	17ENB6N / 17ENB6L	21ENB6N / 21ENB6L	26ENG6N / 26ENG6L	32END6N / 32END6L
Flow Rate (l/min @ 25° rise)	21	26	17	21	26	32
Min Operating Flow Rate (l/min)	2.4	2.4	2.5	2.5	1.5	2.0
Gas Consumption MJ/h - NG	145	175	126	159	195	250
Gas Consumption MJ/h - LPG	149	185	127	159	195	250
Star Rating	6.7	6.7	6.0	6.1	6.4	5.8
Gas Type	NG or LPG	NG or LPG	NG or LPG	NG or LPG	NG or LPG	NG or LPG
Weight (kg)	17	18	14	15	16	30
Max. Temp. Pre-set 50°C Model [†] (°C)	50	50	50	50	50	50
Max. Temp. Unlocked Model [†] (°C)	60	60	60	60	70	75
Max water supply pressure (kPa)	1000	1000	1000	1000	1000	1000
Min water supply pressure (kPa)	200	200	200	200	200	200
Cold Water Connection	20mm ¾"	20mm ¾"	20mm ¾"	20mm ¾"	20mm ¾"	20mm ¾"
Hot Water Connection (mm)	20mm ¾"	20mm ¾"	20mm ¾"	20mm ¾"	20mm ¾"	20mm ¾"
Gas Connection (mm)	20mm ¾"	20mm ¾"	20mm ¾"	20mm ¾"	20mm ¾"	20mm ¾"
Flue Diverter Horizontal Part No.	CF-S37	CF-S37	CF-L39	CF-L38	Short - CFFD26S Long - CFFD26L	CF-L7
Flue Diverter Upward Part No.	-	-	-	-	-	CFC28
Recess Box (Half Cover)	RBM7	RBM7	RBM7	RBM7	RBM8	RBM5
Recess Box (Full Cover)	-	-	-	-	RBM8C	-
Pipe Cover	CF-H33-K450	CF-H33-K450	CF-H33-K450	CF-H33-K450	CF-H33-K450	CF-H32-K450

DIMENSIONS (MM)	CONDENSING MODELS			NON-CONDENSING MODELS		
Model	21L/min	26L/min	17L/min	21L/min	26L/min	32L/min
A Width	350	350	350	350	350	464
B Depth	170	170	170	170	170	240
C Height - Unit	520	520	520	520	520	615
D Height - Including Brackets	575	575	575	575	575	678
E Hot Water Outlet	45	45	40	40	71	70
F Cold Water Inlet	87	87	80	80	55	140
G Gas Inlet	40	40	40	40	62	87
Gas Inlet Length	50	50	50	50	44	51
H Cold Inlet Length	48	48	48	48	53	55
Hot Outlet Length	45	45	45	45	45	44
I Drain Outlet	21	21	N/A	N/A	N/A	N/A
J Hot Water Outlet	30	30	37	37	64	60
K Cold Water Inlet	102	102	139	139	179	244
L Gas Inlet	296	296	296	296	252	361

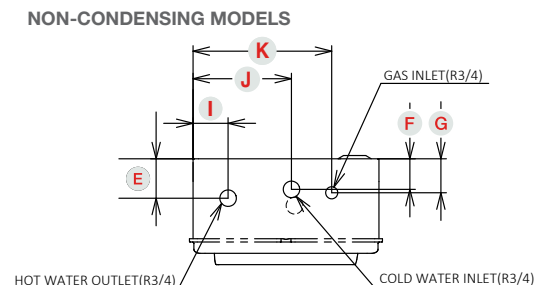
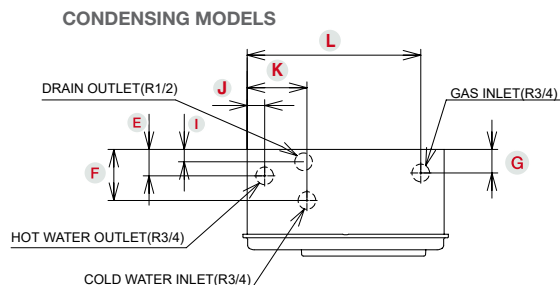
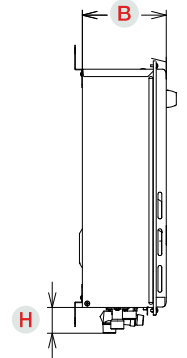
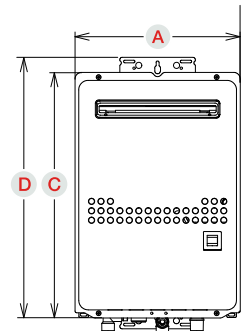

ECOSMART[®] BOOSTED SOLAR

TANK SPECIFICATIONS	250L	315L	400L
ELECTRIC BOOSTED MODEL	250DPM36	315DPM36	400DPM36
GAS BOOSTED MODEL	250DP0	315DP0	400DP0
Storage Capacity (L)	258	323	420
Element Boost Capacity (L) - Electric only	120	146	230
Net Tank Weight Empty (kg)	72	92	116
Relief Valve Pressure (kPa)	1000	1000	1000
Max Inlet Pressure (kPa)	800	800	800

TANK DIMENSIONS (MM)	250L	315L	400L
A Tank Height	1440	1760	1700
B Tank Diameter	730	730	820
C Outlet Height	1210	1530	1445
D Solar Return Height	640	845	645
E Pump Outlet Height	520	520	545
F Inlet Height	195	195	220
G Electrical Entry Height (Electric only)	680	880	695

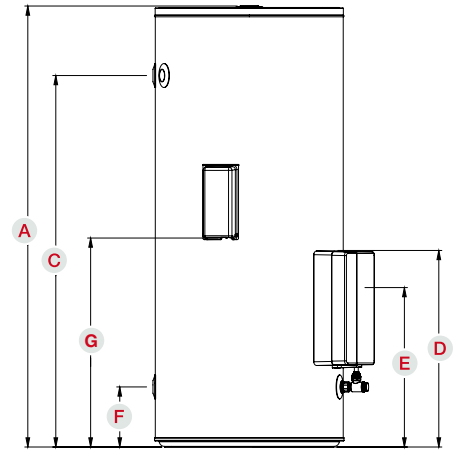
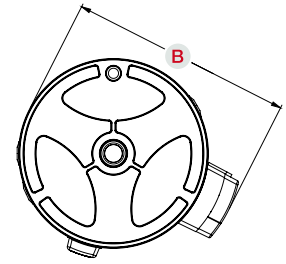

GAS BOOSTER SPECIFICATIONS

BOOST SPECIFICATIONS		DIMENSIONS (MM)	
Gas Continuous Flow	26L/min	A Width	350
Gas Consumption (MJ/Hr)	195	B Depth	170
Gas Type	Natural /LPG	C Height - Unit	520
Cold Water Socket Size (mm)	RP3/4"/20	D Height - Including Brackets	575
Gas Pipe Inlet Size (mm)	RP3/4"/20	Gas Connection Length (From Base)	44
Relief Valve Pressure (Kpa)	1000	E Cold Connection Length (From Base)	53
Weight (kg)	16	Hot Connection Length (From Base)	45

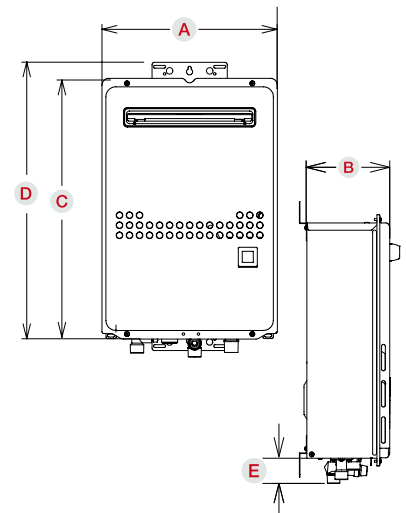

SOLAR COLLECTORS

PANEL SPECIFICATIONS	FSA20	PANEL DIMENSIONS (MM)	
Total Area (m ²)	2	Panel Height	2000
Weight Without Water (kg)	35	Panel Width	1000
Glass Thickness (mm)	3.2	Panel Depth	95
Glass Material	Low iron tempered textured glass		
Absorber Material	Black chrome, selective surface (aluminium plate)		
Copper Rises	8		



.....

100
YEARS
MANUFACTURING
IN AUSTRALIA

1300 365 116

dux.com.au

*WARRANTY

Full warranty terms and conditions are in the product's Owners Manual,
visit www.dux.com.au/warranty-terms for full details and conditions which apply.

Sales: **1300 365 116** Service: **1300 365 115** or visit **dux.com.au** for more.

© 2022 Dux Manufacturing Limited ABN 19 077 879 844. Lackey Rd, PO Box 209 Moss Vale, NSW 2577.

The information supplied was correct at time of printing. Specification and materials may change without notice.

® and ™ Trademarks of Dux Manufacturing Limited.

FEB2023